

EKD01_AKSM Displayer Manual



Version record

Version	Revised By	Date	Changed Content	Remarks
V1.0	MO,HAOQI	2023.03.08		
V1.1	MO,HAOQI	2023.06.12		
V1.2	MO,HAOQI	2023.09.11	Add hot plug operation warning; initial password and advanced password description optimization	
V1.3	WEN,YAO	2024.09.02	Update the add voltage level menu	

Directory

EDK01-AKSM DISPLAYER MANUAL	1
VERSION RECORD.....	2
DIRECTORY	3
I. PRODUCT INTRODUCTION	4
1. Name	4
2. Product model	4
3. Product appearance	4
4. Product Specifications	4
5. Lordinterface	5
6. Button definition	5
7. General Operations	7
II. INFORMATION VIEWING AND SETTING	9
1. Display settings	9
2. Information viewing	11
3. Language selection	13
4. Theme menu	14
5. Password settings	14
6. Bluetooth connection	16
7. Factory reset	210
ERROR CODE COMPARISON TABLE	22

Note: 1、 Due to the upgrade of the company's products, the product display content you get may be different from the manual, but it will not affect your normal use.

2、 Do not plug and pull live, which may damage the electronic control accessories.

I. Product introduction

1. Name

Smart Displayer instrument.

2. Product model

EKD01-AKSM

3. Product appearance



4. Product Specifications

General Parameters		
Dimensions	Length*Width*Height	86.8*50.5*12.5 (mm)
	Screen Size	2.4"
	Holder Diameter	22.2 (mm)
Screen	Type	IPS
	Color	RGB
	Image Resolution	320*240PX
Connector	Type	M5 Waterproof Connector
	Length	23 cm
General Feature	Voltage	36V/48V/52V
	Working Temperature	-20 °C - +70 °C
	Waterproof Level	IP67
	Weight	67g
Other Feature	Communication Protocol	UART
	Bluetooth	4.0 + BLE
	Type-C interface	Support
Certification	RoHS/CE/FCC	Support Customization

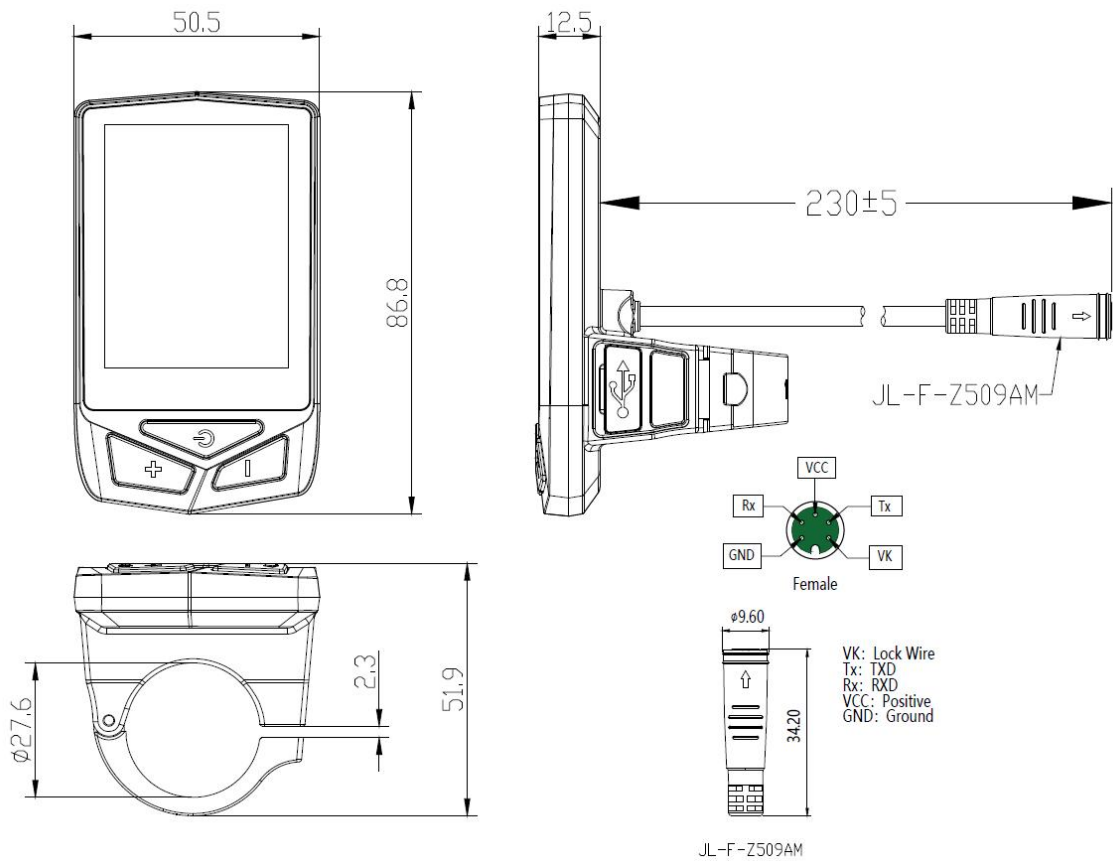

5. Lordinterface

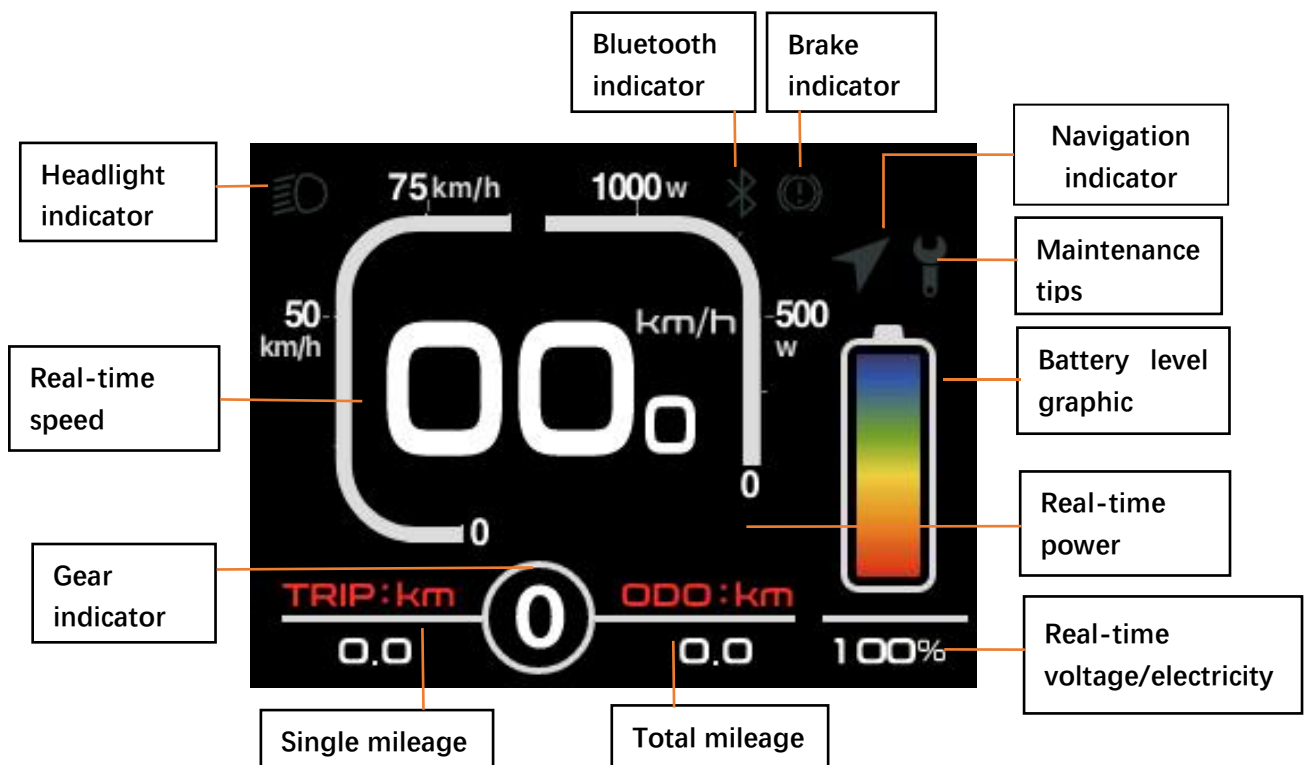

- ① Headlight indicator: The headlight indicator graphic will light up when the headlight is on.
- ② Navigation indicator: If the BIKEGO app is connected to the instrument, the symbol will light up when navigation begins. (Live navigation requires payment).
- ③ Maintenance tip: Electronic systems have some ability to self-diagnose and report limited faults. The failure is reported as an error code displayed on the screen.
- ④ Brake indicator: This icon lights up when the vehicle performs a brake operation.
- ⑤ Bluetooth indicator: After the APP is successfully connected to the instrument, the symbol will light up.
- ⑥ Battery Level graphic: The Battery Level graph is a graphical representation of the remaining charge in the battery. After the battery is charged, more bars will appear in the graph. When the battery runs out, fewer bars appear.
- ⑦ Real-time speed: Displays the current speed at which the e-bike is traveling.
- ⑧ Real-time power: Displays the current power at which the e-bike is traveling.
- ⑨ Gear indicator: Displays the current assist gear of the electric bike.
- ⑩ Single mileage: The number of miles in a single trip.
- ⑪ Total Mileage: The total number of miles traveled by the vehicle.
- ⑫ Real-time voltage/electricity: Display the voltage situation or electricity of the battery in real-time synchronization.

6. Button definition

The EKD01-AKSM has 3 buttons. Includes Power key,  plus key +, minus key -.

The key definition is shown in the following figure:



7. General Operations

EKD01-AKSM provides 4 themes and 3 languages for users to set up, this manual uses Theme 1 (English version) as an example.

"Press and hold the key >2.5 seconds" is replaced with "long press", "long key <0.5 seconds" is replaced with "tap".

① On/Off

Press "⏻" to power on/off the monitor. In the shutdown state, the current of the display is less than 1uA. The boot screen is shown in the following figure.

(You need to enter the password before entering the main screen, the default password is 0000).



② Gear level selection

After entering the main display, click "+" or "-" to increase or decrease the gear level and change the motor output power, the default gear of the instrument is 0-5 (support customization); No power output in 0 gears, 1 is the

lowest power, and 5 is the highest power. When the monitor is powered on, the default setting is Gear 0. The gear level selection screen is shown in the following figure:

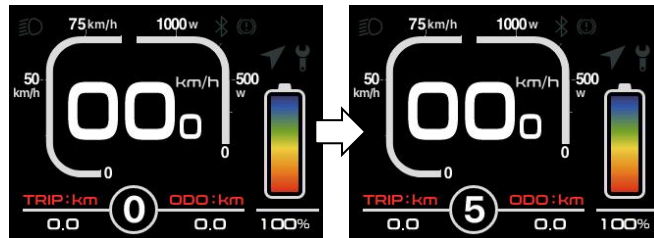

③ Headlight/backlight switch

Turn on the light: Press and hold "+" when the light is off, the headlight indicator lights up, and the brightness of the display dims.

Turn off the lights: When the light is on, press and hold the "+" key, the headlight indicator becomes dimmed, and the display brightness becomes brighter.

The headlight switch interface is shown in the figure below:

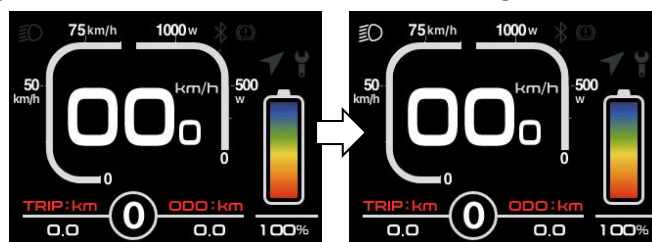

④ Boost mode

In any gear, long press "-" to enter boost mode, the speed is 6km/h, when entering boost mode, the icon "" is in dynamic, release the button" - "exit boost mode, boost icon "" disappears, and the speed returns to zero.

The interface is shown in the following figure:

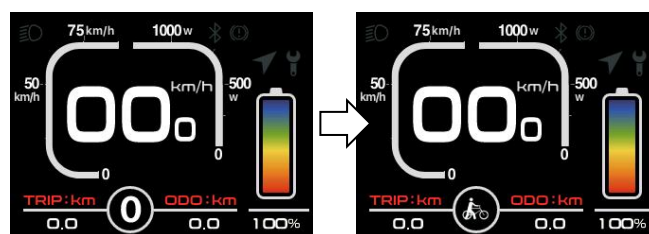

In boost mode, the indicator is displayed dynamically. When the speed is lower than 6km/h, release the "-" to exit the boost state. If there is no operation within 5 seconds under static, it will automatically jump to 0 gear.

⑤ reverse charging

Use the USB cable to connect the instrument- -mobile phone and other devices, which can be charged to the mobile phone and other devices through the instrument, charging specification: 5V-1A.

II. Information viewing and setting

1. Display settings

Click "⏻" to enter the settings menu, use "+" or "-" to move the cursor up and down, select "Display Settings", "Information", "Language", "Theme", "Password", "Bluetooth", "Reset Factory Settings" and "Exit", and click "⏻" to operate.

The interface is shown in the following figure:

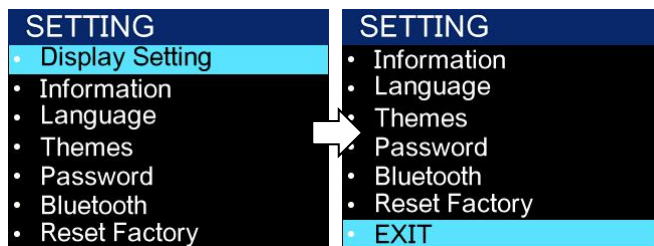

① Imperial and metric unit conversion

Enter the "Display Settings" menu, select "Units", click "" to enter the settings, use "+" or "-" to move the cursor up and down after entering the settings, select "Metric"/"Imperial", click "⏻Save to exit "Units", exit the main interface through "Return" →. (The entry and exit procedures for other settings are similar and will not be repeated).

The unit conversion is shown in the following figure.

Note: The default units are imperial.



② Automatic shutdown operation

Go to the "Auto Off" menu and select "OFF", "1 minute", "2 minutes", "3 minutes", "4 minutes", "5 minutes", "6 minutes", "7 minutes", "8 minutes", "9 minutes", "10 minutes" ("OFF" means to turn off the function, "1min-10min" means the time of automatic shutdown, respectively).

Note: Any operation within the auto-off time will be timed again, and no shutdown will occur until the non-operational time reaches the auto-off time. When the instrument is connected to the bikego app via Bluetooth, the automatic shutdown function will fail.



③ Mileage reset

Go to the "ODO Reset" menu and select "No"/"Yes".

It will be reset automatically when the mileage reaches the maximum (655km) (maximum varies by protocol), or go to the menu and select "Yes" to clear all mileage. The interface is shown in the following figure:

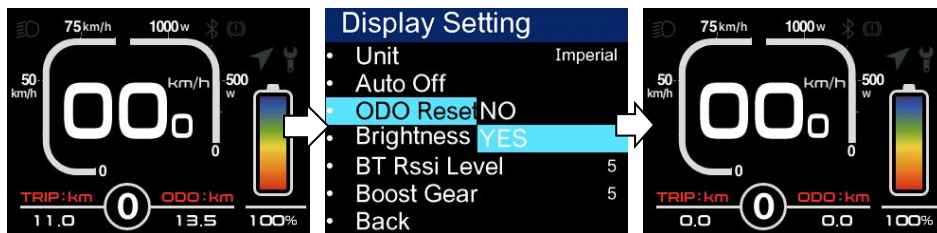

On the main interface, press and hold the "+" and "-" keys at the same time to achieve zero TRIP and AVG, as shown in the following figure:



④ Backlight brightness setting

Go to the "Brightness" menu and select "30%"/"50%"/"75%"/"100%".

The interface is shown in the following figure:

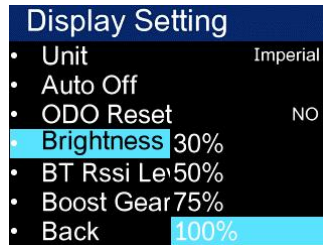

⑤ BT Rssi Level – Bluetooth distance level setting, level 5 is the maximum range, 4-1 range decreases in order, as shown in the following figure:

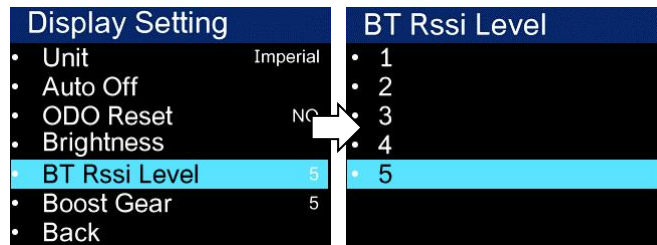

Note: This varies slightly from phone to phone.

⑥ Boot Gear gear number selection, default 5 gears, at this time the instrument 0-5 gears are adjustable; When switching to 3 gears, the instrument 0-3 gears are adjustable; When switching to 9 gears, the instrument 0-9 gears are adjustable, as shown in the figure below

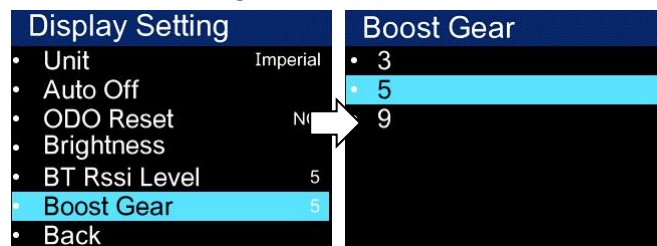

2. Information viewing

① Wheel Size Information - Go to the Wheel Size menu (Need to enter the password 2020, which cannot be modified), the default wheel diameter is 26" (660mm) and the setting range is 16" (410mm) - 29" (740mm).

As shown in the following figure:

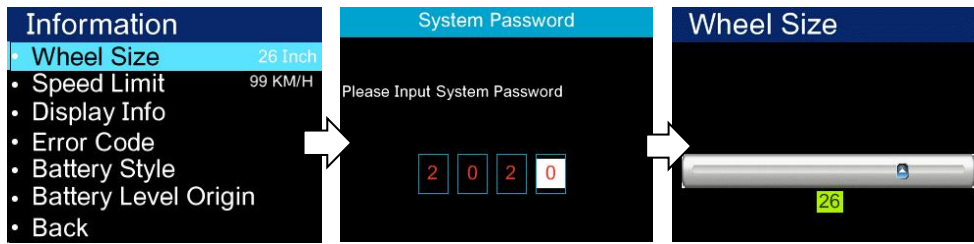

② Speed Limit Information - Go to the Speed Limit menu (Need to enter the password 2020, which cannot be modified). When the unit is kilometers (metric), the default speed limit is 99 km/h, 0~99km/h optional.

As shown in the following figure:



Note: The combination of "+" key and power key on the main interface can quickly switch between speed limit and no speed limit modes.

③ Display Information – Go to the Display Information menu to display the software and hardware version numbers (varies by product).

As shown in the following figure:

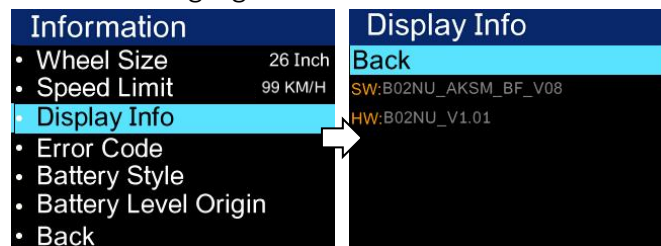

④ Error Code – Go to the Error Code menu, "E-CODE 0" refers to the last error message, and "E-CODE 9" refers to the tenth error message. Records can have up to 10. Press "+" or "-" to toggle. Error code "00" indicates no error. For the meaning of the other codes, see the error code definition table. As shown in the following figure:

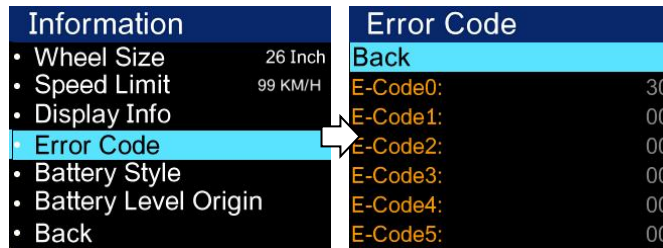

⑤ Power and voltage switching menu: you can switch the power percentage or voltage display on the main interface, as shown in the figure below:

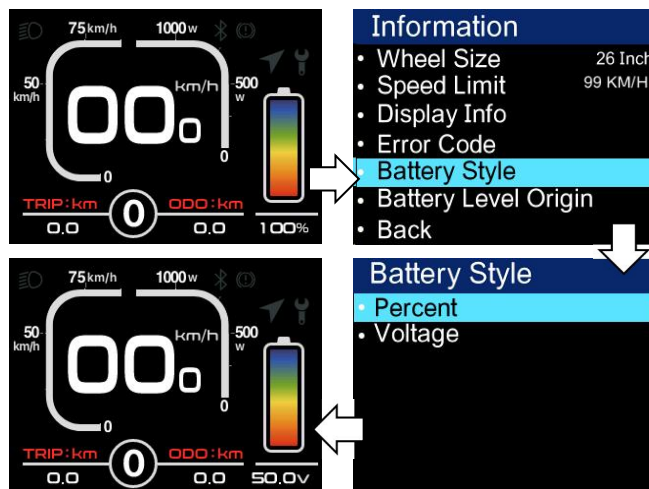

⑥ Voltage level menu: it can be switched to different voltage levels, the default is CON, optional CON / 36V / 48V / 52V, as shown below:

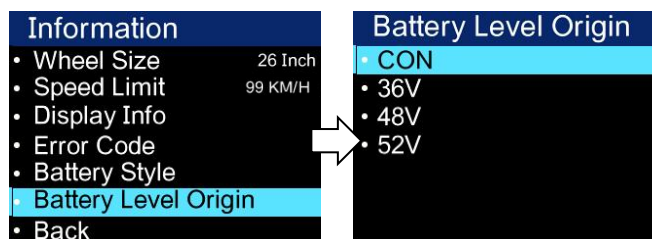

3. Language selection

EKD01-AKSM is available in 8 languages for users to choose from. Go to the "Language" menu and select a different language switch.

The interface is shown in the following figure:



4. Theme menu

EKD01-AKSM offers 4 different themes for users to choose from. Go to the "Theme" menu and switch between "Theme 1" - "Theme 2" - "Theme 3" - "Theme 4".

The interface is shown in the following figure:

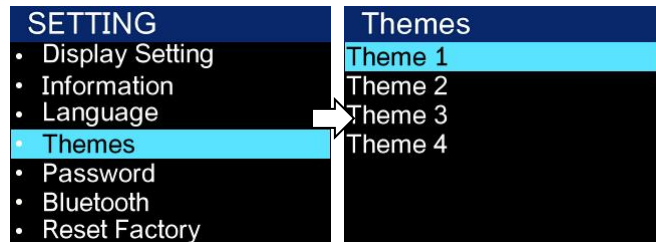

5. Password settings

① Start password off/on. Enter the "Password" menu, select and enter the "Startup Password" (status is on/off) menu, and the interface prompts you to enter the password (The default password is 0000). At this time, use the "+" or "-" keys to switch the numbers "0-9" and press "" to enter the number. After entering, you will be prompted to turn off/on the password function. Then the interface will jump to the original menu automatically.

The interface is shown in the following figure:

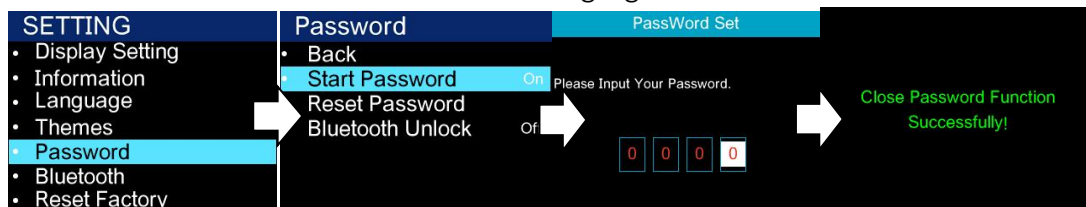

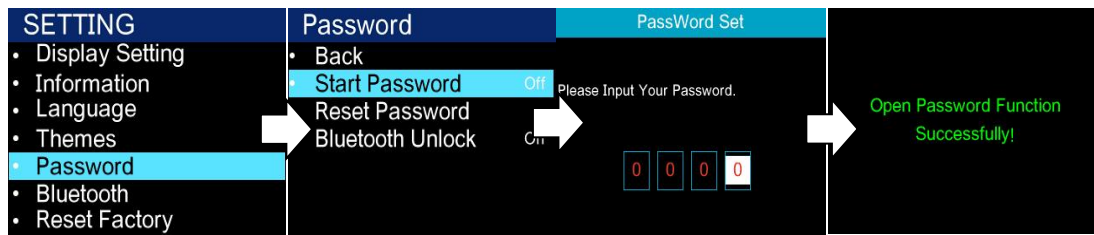

② Reset Password – Go to the Reset Password menu. (The default password is 0000)

1. The interface prompts "Please enter your old password". At this time, use the "+" or "-" keys to switch the numbers "0-9" and click "OK" to enter the number.

2. After entering, the interface prompts "Please enter your password". Repeat once to enter a new password.

3. After entering, the interface prompts "Please confirm password". Repeat this once.

Note: If you want to enable the password feature, you need to enter a new password after modification.

Do not change the initial password arbitrarily.

After modification, the interface will automatically jump to the original menu .

As shown in the figure below:

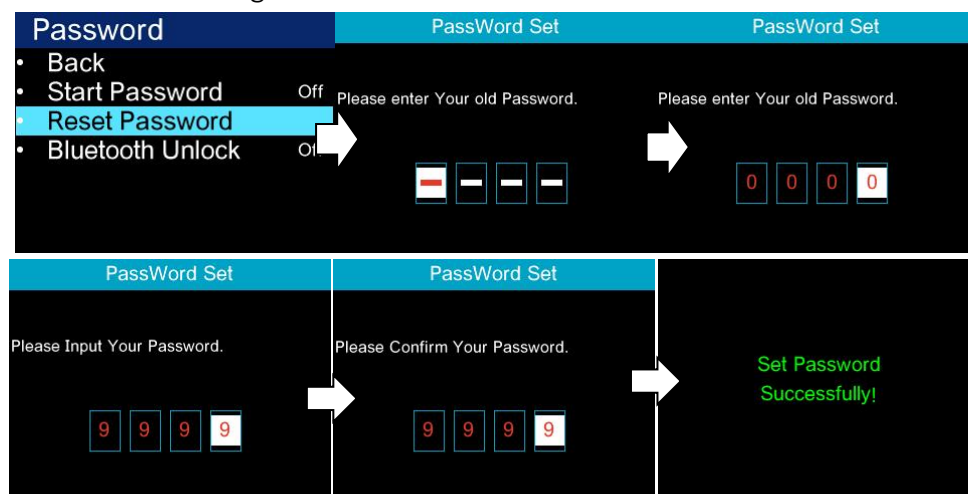

③ Bluetooth unlock setting (turned off by default, needs to be turned on

manually).

Go to the Bluetooth Unlock menu, click "+" or "-" to select On/Off ("On" means to enable it, "Off" means to disable it). If Bluetooth unlock is enabled when the mobile app is not connected, a Bluetooth QR code interface will pop up for you to bind.

The result is as follows:

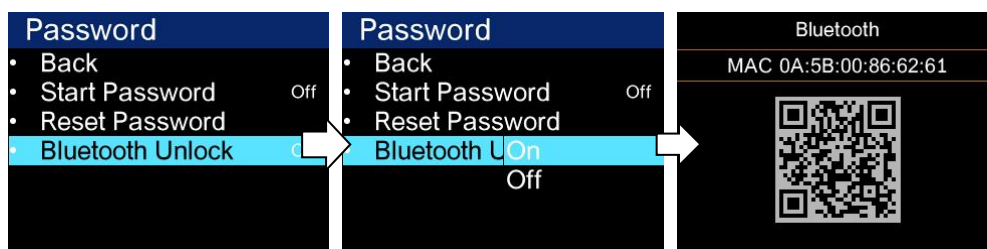

6. Bluetooth connection

Short press "" to enter the menu interface, enter the "Bluetooth" menu, click "" to enter the Bluetooth QR code interface. You can scan the QR code through the mobile APP to bind the device. After binding, you will automatically jump to the home screen and the Bluetooth indicator lights up.

Note: App information

Android SDK 9 and above

Domestic: <https://www.pgyer.com/LST2> Abroad:

<https://apkpure.com/cn/bikego/com.huiye.ebike>

IOS SDK 12 and above

<https://apps.apple.com/cn/app/bikego/id1615694432>

The operation is as follows (using the iPhone as an example):

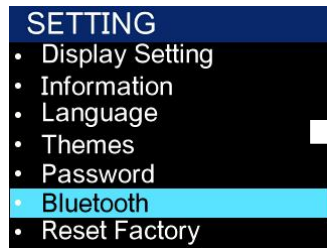

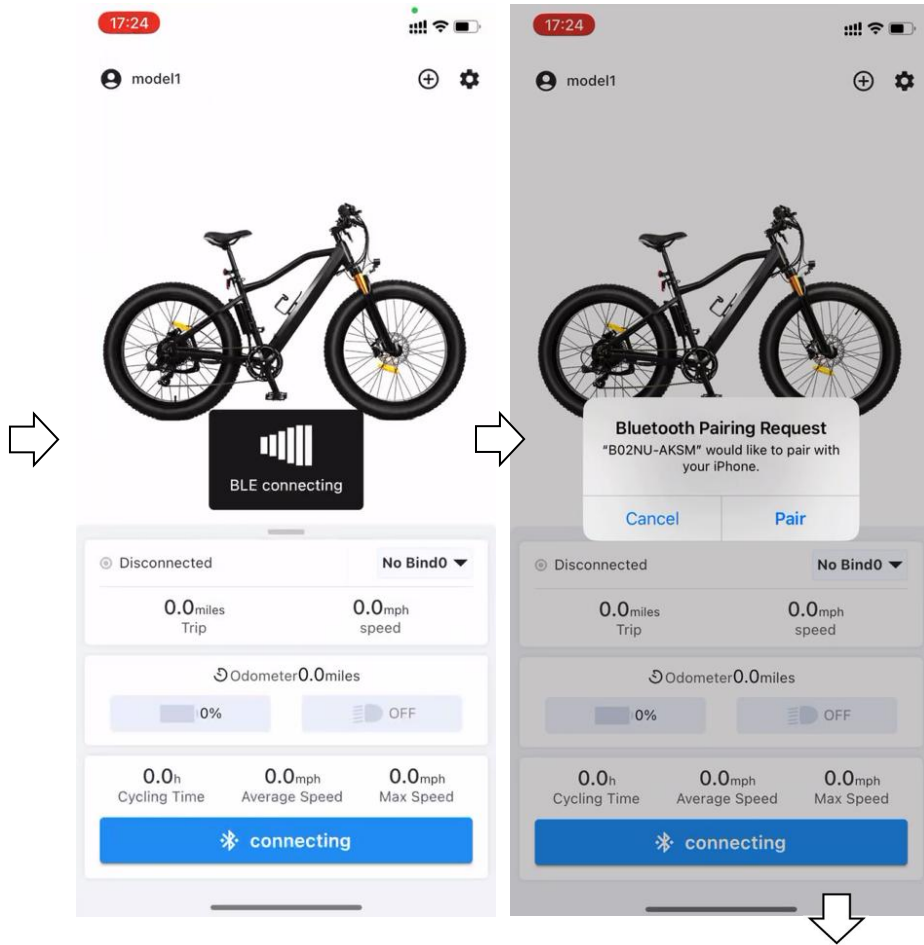

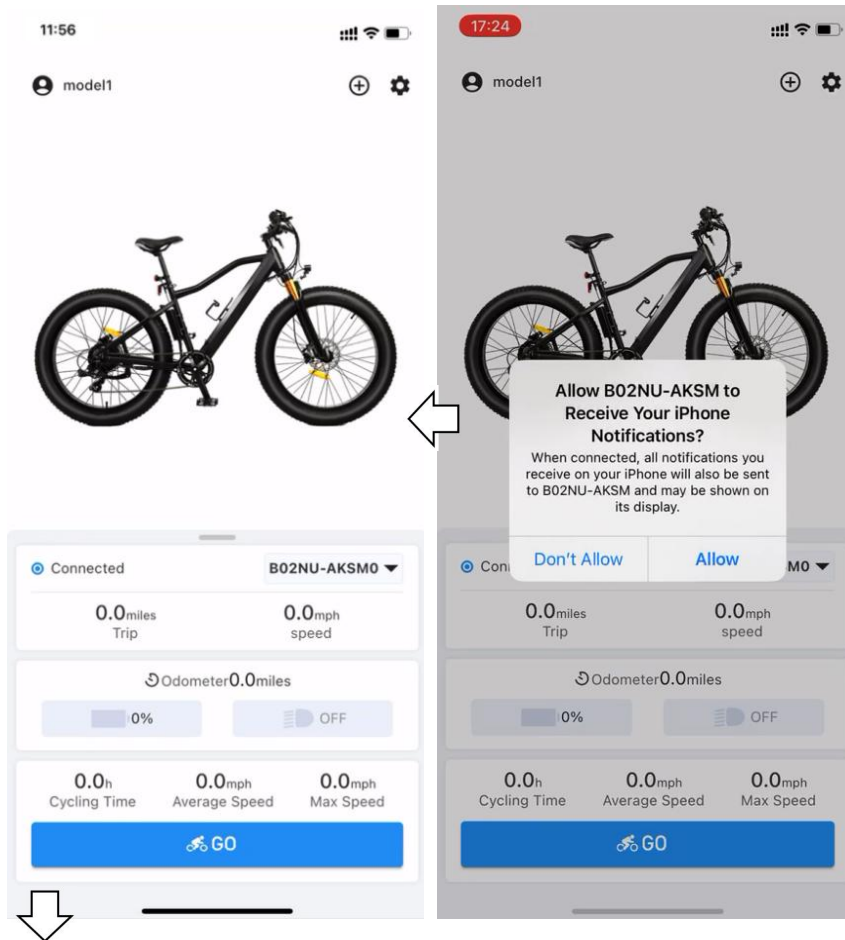

After connecting the Bluetooth of the display screen successfully, click "GO" on the main interface of the APP to enter the navigation interface to select the destination, and when you start navigation, the display changes as follows (real-time navigation requires payment):

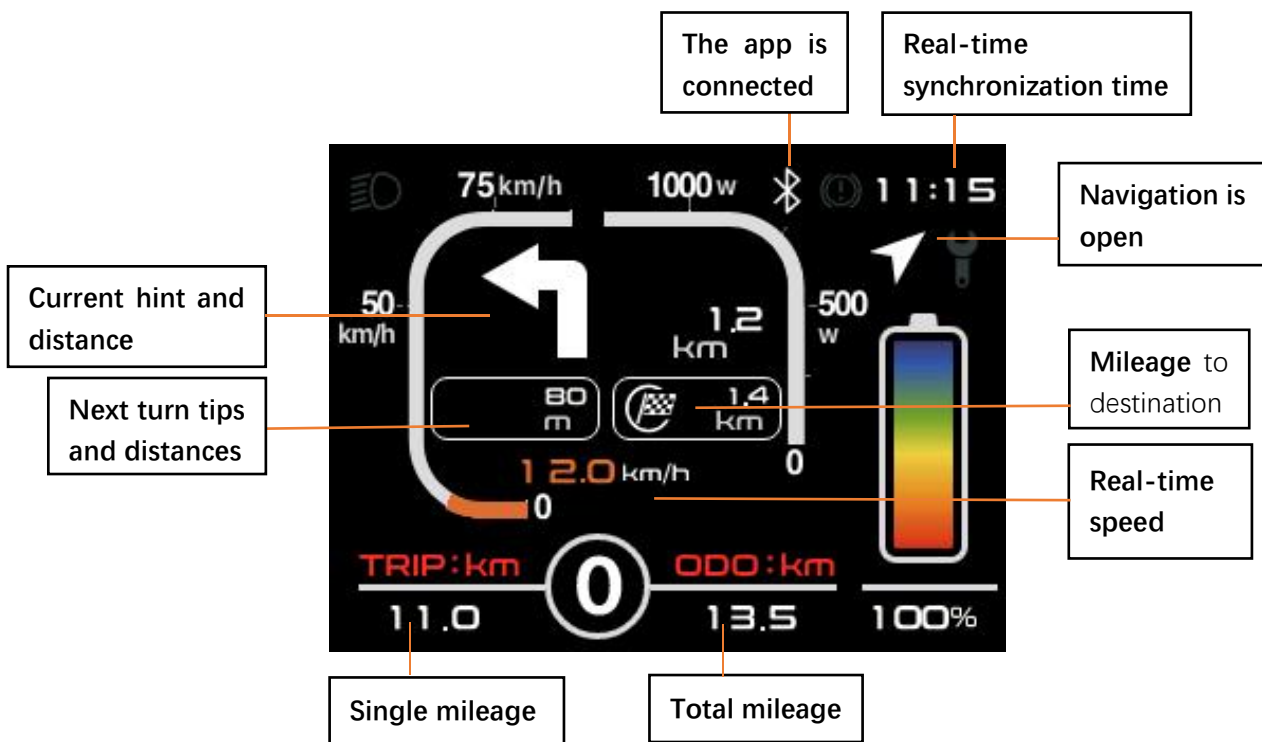

Navigation indicator: The symbol lights up to indicate that it is now in the navigation interface.

Bluetooth indicator: The symbol lights up to indicate that the mobile app is now connected to the instrument.

Real-time synchronization time: When the instrument is connected to the app, the mobile phone time will be displayed to the instrument in real time, and the time of disconnecting the Bluetooth connection will not be cleared. Only when the instrument is restarted, the time will be cleared

Current hint and distances: Turn tips and distances during the current drive.

Next turn tips and distances: Next turn tips and distances during driving.

Mileage to destination: Indicates the total distance from your current location to your destination.

Users sign up for the first time with 200 map searches, 5 navigation projections, and a 1\$ 5\$ 10\$ package option. As shown below:

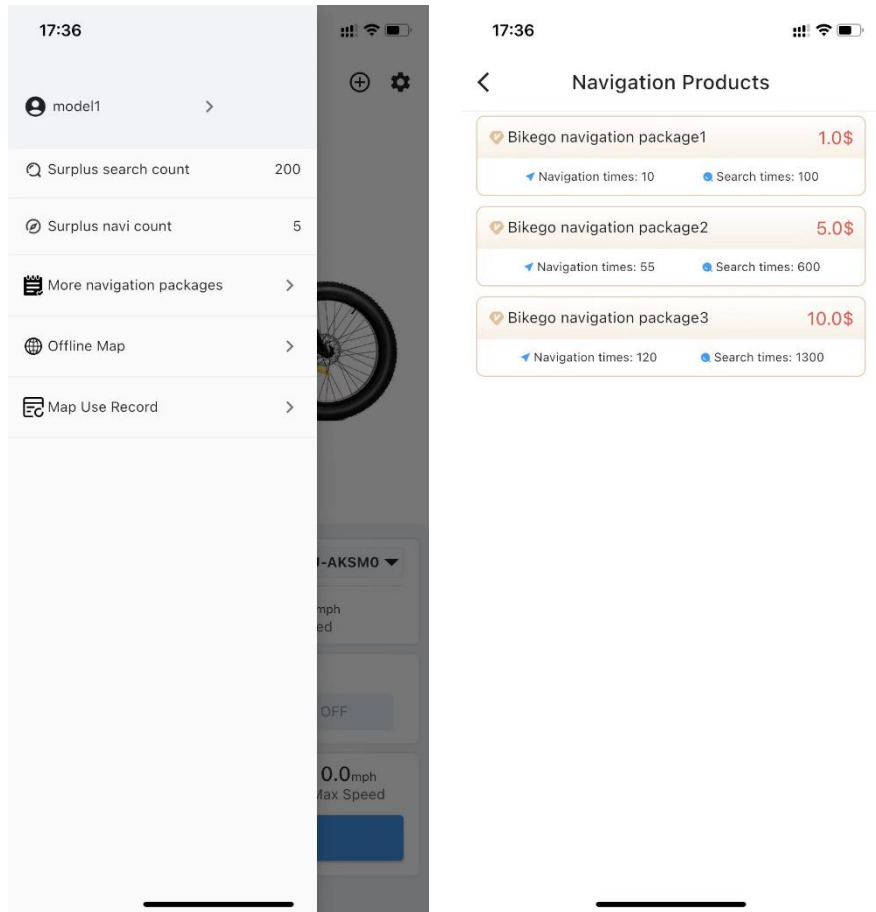

7. Factory reset

Short press "⏻" to enter the menu interface, click "⏻" to enter the factory reset interface. Select confirm, after a short press on "⏻", the instrument restarts and restores factory settings; Select cancel, briefly press "⏻", and return to the previous menu, as shown in the following figure:



Error code comparison table

Error code	Description of the fault	Troubleshooting methods
"04"	The speed control put has no homing	Check that the handle is in place
"05"	Speed regulation put failure	Check the handlebar
"07"	Overvoltage protection	Check the battery voltage
"08"	The motor Hall signal line is faulty	Check the motor module
"09"	Motor phase line failure	Check the motor module
"11"	Controller temperature sensor failure	Check the controller
"12"	Current sensor failure	Check the controller
"13"	Battery internal temperature failure	Check the battery
"14"	Temperature failure in the motor	Check the motor
"21"	Speed sensor failure	Check where the speed sensor is installed
"22"	BMS communication failure	Replace the battery
"30"	Communication failure	Check the controller connector